

Time Lapse Camera

TLC 2000 / TLC 2020

User Manual

Copyright © 2019 Brinno All Rights Reserved

Register your camera online to earn
an extra 6 months warranty!

Register Online and get

6 **EXTRA**
MONTHS
WARRANTY



www.brinno.com/support/registration

Register your camera for a free 6 month warranty extension
and receive direct notification of firmware updates.

brinno
brilliant innovation

CONTENTS

Before You Start

What's in the Box	8
Camera Parts	10

Initial Operation

Install batteries	13
Battery type	14
Install microSD card	15
USB-C Cable	16
Power On/Off	17
Check your camera firmware	18
Power saving mode	19
LED indicator	20
Set date & time	21
Start recording	22

CONTENTS

Stop recording	23
Menu change (option)	24
Quick menu mode operation	
Display icons (quick menu mode)	26
1. Scene settings	27
Scene	28
2. Menu settings	30
Menu (quick menu mode)	31
3. Schedule settings	33
Schedule mode	35
Full menu mode operation	
Display icons (full menu mode)	37
1. Capture mode settings	38
Capture modes	39
Start/Stop recording-Time Lapse & Step Video	40

CONTENTS

Start/Stop recording-Stop Motion	42
Start/Stop recording-Still	44
2. Menu settings	45
Menu (full menu mode)	46
3. Interval settings	49
Specifications	51
Battery Setting	52
Downloading and installing the latest firmware	53
Support	
Tutorial Video	56
Time Lapse Calculator	57
Manual in multi-languages	58

Before You Start

WHAT'S IN THE BOX (TLC2000)



TLC2000

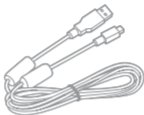

USB-C Cable

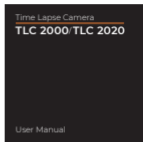

User Manual



2 AA Batteries



Screwdriver



Lens Cover



microSD Card

WHAT'S IN THE BOX (TLC2020)



TLC2020



Battery Cover Adapter

*To be used with the ATH2000 Construction Power Housing Accessory.



USB-C Cable



4 AA Batteries



Lens Cover

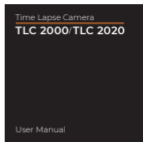

User Manual



Screwdriver



microSD Card

CAMERA PARTS

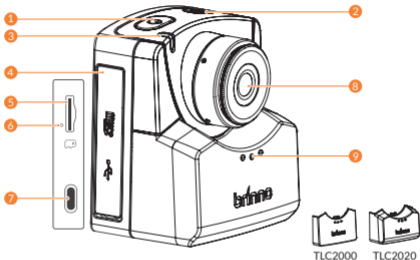

1. Power Button
2. Shutter/
Back to Preview Button
3. LED Status Indicator
4. Memory Card Door
5. microSD Card Slot

6. Camera Reset Button
7. USB-C Socket

▲ Only can be used as an external power supplier & data transfer, CANNOT be used to charge batteries.

8. Lens
9. Battery Door

CAMERA PARTS

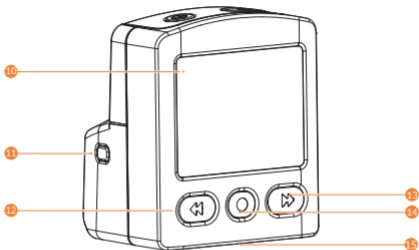

10. LCD Screen

11. Circuit Indicator

12. Previous Button

13. OK Button

14. Next Button

15. Tripod Mount (size: $\frac{1}{4}$ ")

Initial Operation

INSTALL BATTERIES (TLC2020)

OPEN - Press the center of battery door to release the latch inside, and open battery door.

CLOSE - Along the track on the camera and push the center of the bottom side of battery door to close.

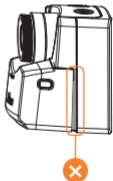
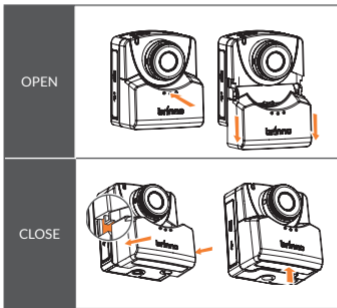

BATTERY TYPE

Battery type: Please select the correct battery type in the menu settings to optimize battery life. For information on how to change battery type in settings please go to page 52.

Alkaline	Default setting. The batteries that come with your camera will be Alkaline.
NiMH	Most rechargeable batteries are NiMH type.
Lithium	Energizer Lithium AA batteries.

⚠ We DO NOT RECOMMEND USING ZINC-CARBON BATTERIES.

⚠ Only replace all batteries at a time, DO NOT SWAP SINGLE BATTERIES. Swapping one used battery out for a fully charged one can cause the camera to malfunction.



Circuit Indicator

Press the circuit indicator once to see if the batteries have been installed correctly, if the button lights up green then you are ready to start filming. If there is no light, you need to make an adjustment to your battery placement.

INSTALL microSD CARD

Open the memory card door and insert microSD card.

- !** Supports up to 128GB microSD card. For 64 or 128 GB microSD card, follow instruction on the LCD screen to **format the card before using it the first time.**



TLC 2020

USB-C Socket

The USB-C Socket can only be used as an external power supplier and data transfer point.

External Power Supplier

Plug your camera into an external power outlet using the USB-C Cable. If you are using an external power supply, we recommend you still install fully charged batteries as a back-up.



⚠ Refrain from using a power bank or solar panel as external power supplier.

Batteries cannot be recharged while inside the camera. When batteries are low on energy please remove and replace/recharge them.

Data Transfer

Plugging your camera into a computer can only be used for data transfer. Your computer will NOT allow you to record while it is plugged in and will only allow you to view and download previously recorded footage.

POWER ON/OFF

Open the memory card door and insert microSD card.

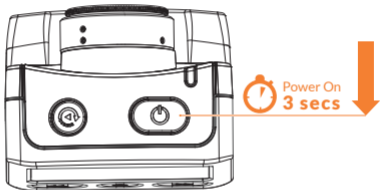

1. Power on: hold "**Power Button**" for 3 secs.
2. Power off: hold "**Power Button**" for 3 secs.

CHECK YOUR CAMERA FIRMWARE

1. Go to SYSTEM INFO (**MENU > MORE > System Info**) check your time lapse firmware is the latest version.



2. You can find and download the latest firmware version on the Firmware Download Site :



www.brinno.com/support/download#TLC2000series



If your Time Lapse Camera is not the latest firmware, refer to the **page 53** to learn details about **downloading and installing the latest firmware**.

POWER SAVING MODE

When the camera is turned on but not recording:

Sleep Mode

The camera goes into sleep mode to save power after 25 seconds without activity. The LED indicator turns solid **Green**.

Press "●" button to wake up the camera.

Power off

The camera shuts down after 60 seconds without activity.

 After 25 Secs

 After 60 Secs

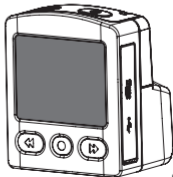
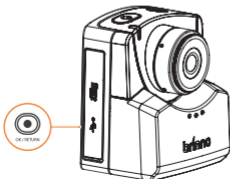

LED indicator

Green

The LED flashes Green every **10 seconds** while recording.
(Time Lapse mode)

Red

Out of batteries/No SD card/SD card error.

Orange

While firmware is updating, LED indicator will flash Orange.

! For more information on **checking your camera firmware** refer to **page 18**,
downloading and installing the latest firmware detail refer to **page 53**.

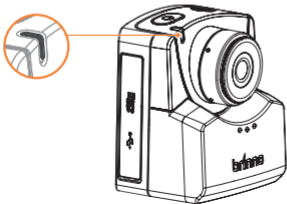

SET DATE & TIME

The date & time menu appears when the camera is first turned on.



1. Set the numeric value using “◀/▶”.
2. Press “●” button to confirm and go to next option.

START RECORDING

1. Press "**SHUTTER**" button to start recording.
2. The LCD screen displays "**REC**" icon along with *beep sound*.
The LCD screen then turns off to save power.

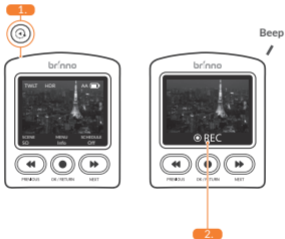

STOP RECORDING

1. Press "**SHUTTER**" button to wake up LCD screen. The camera stops recording and starts post-editing video immediately.
2. LCD screen displays "**PROCESSING**" icon accompanied by **beep sound** to confirm the completion of video post-editing.
3. The camera returns to PREVIEW SCREEN after the video is completed.

 Note: 3 beeps for time lapse mode; 4 beeps for step video mode

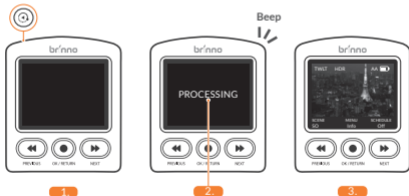

 To view recorded footage, SD card must be removed or camera must be plugged into a computer using the USB-C cable.

MENU CHANGE (option)

Quick Menu is the default on the TLC2000/ TLC2020. If you would like more detailed settings through the Full Menu you will need to change it in settings.

1. On the PREVIEW SCREEN press “●” button and then the “▶▶” button to go to the MENU page. The current menu setting will be listed.
2. If it is not your desired menu style press the “●” button to change the setting. Use the “◀◀” and “▶▶” buttons to choose the menu setting you would like and then press the “●” button to set. When the new menu is set you will be returned to the preview screen.



1.



2.



Quick menu mode operation

DISPLAY ICONS (Quick menu mode)



1. Scene
DAY: Daytime
TWLT: Twilight
NITE: Night
2. HDR
3. Schedule
4. Battery indicator
5. Scene setting
6. Menu/Info
7. Schedule setting

1. SCENE SETTINGS

- 1-1. At PREVIEW SCREEN, press “◀” button to go to SCENE SETTINGS screen.
- 1-2. Press “◀” and “▶” to select desired SCENE MODE and press “●” button to confirm and return to PREVIEW SCREEN.



! Each scene setting will produce a different video playback length. Select a scene based on all your filming needs including required video length. If none of the preset scenes fit your needs, switch your camera to full menu mode ([page 24](#)) and manually select filming settings ([page 45](#)). Use the time lapse calculator on our website ([page 57](#)) to figure out what film settings are right for you.

1. SCENE

Capture scene	Initial	Description	
Short Outdoor Construction	SO	Interval: 1 min HDR: On Video length per hour: 3 seconds Scene for : <i>Short outdoor construction project</i>	EXPO mode: <i>Twilight</i> FPS: 20
Long Outdoor Construction	LO	Interval: 5 min HDR: On Video length per hour: 0.6 seconds Scene for : <i>Long outdoor construction project</i>	EXPO mode: <i>Twilight</i> FPS: 20
Indoor Construction	IC	Interval: 3 min HDR: On Video length per hour: 1.0 seconds Scene for : <i>Indoor construction project</i>	EXPO mode: <i>Twilight</i> FPS: 20
Night Construction	NC	Interval: 5 min HDR: On Video length per hour: 0.6 seconds Scene for : <i>Night construction project</i>	EXPO mode: <i>Night</i> FPS: 20

1. SCENE

Capture scene	Initial	Description	
Indoor Event	IE	Interval: 20 sec HDR: On Video length per hour: 9 seconds Scene for : <i>Indoor event</i>	EXPO mode: <i>Twilight</i> FPS: 20
Construction Site Security	CS	Interval: 30 sec HDR: On Video length per hour: 6 seconds Scene for : <i>Surveillance</i>	EXPO mode: <i>Night</i> FPS: 20
Detailed Craftwork	DC	Interval: 5 sec HDR: On Video length per hour: 36 seconds Scene for : <i>Embroidery, Sculpture, Painting, Jewelry</i>	EXPO mode: <i>Twilight</i> FPS: 20
Large Artwork	LA	Interval: 10 sec HDR: On Video length per hour: 18 seconds Scene for : <i>Mural, Woodworking, Large wall art</i>	EXPO mode: <i>Twilight</i> FPS: 20

2. MENU SETTINGS

- 2-1. At PREVIEW SCREEN, press “●” button to go to MENU SETTINGS screen.
- 2-2. At MENU SETTINGS, press “◀” or “▶” button to switch to menu options.
- 2-3. Press “●” button to enter the setting.

⚠ SKIP BUTTON: Press “SHUTTER” button to go back to preview screen.

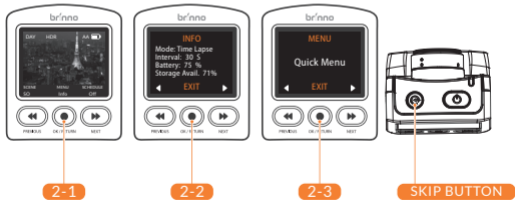

2. MENU (QUICK MENU MODE)

Option	Level I	Level II
INFO	Display current camera status	
MENU	Quick menu	
	Full menu	
IMAGE SETTING	WHITE BALANCE	Auto/tungsten fluorescent (1)/fluorescent (2)/cloudy/ shadow/daylight
	EV	
	CONTRAST	
	SATURATION	
	SHARPNESS	
	Restore image defaults	OK/Cancel
	Return	Return to Main Menu

2. MENU (QUICK MENU MODE)

Option	Level I	Level II
MORE	LED indicator	Yes/No
	DATE & TIME	Set camera date & time
	TIME STAMP	Yes/No
	BAT TYPE	Alkaline/NiMh/Lithium
	RESOLUTION	720P/1080P
	FOCUS	Zoom in/Zoom out/Ok to Exit
	PLAYBACK FPS	1/5/10/20/30/Custom
	System Info.	Camera firmware version
	FORMAT SD CARD	Yes/No
	RESET CAMERA	Yes/No
	RETURN	Return to Main Menu
FLICKER FILTER	None/60Hz/50Hz	
RETURN	Return to Main Menu	

3. SCHEDULE SETTING

- 3-1. At PREVIEW SCREEN, press “▶” button to go to SCHEDULE SETTINGS screen.
- 3-2. Select desired **Continuous** or **Daily** mode and press “●” button to confirm and go to SCHEDULE STATUS SCREEN. Press “●” to go to step 3-3.



3. SCHEDULE SETTING

- 3-3. At SCHEDULE START/STOP SCREEN, set your required filming schedule. Press “ ● ” to save and go to the SCHEDULE DAYS SCREEN.
- 3-4. Select desired recording days of week, select SAVE option to complete the setting and go back to PREVIEW SCREEN.



3. SCHEDULE MODE

Continuous

Camera will auto **COMBINE** several daily files into a **SINGLE AVI FILE**.

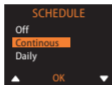

TLC00001

Daily

Every daily recording produces a single **DAILY AVI FILE**.

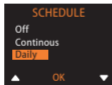

TLC00001



TLC00002



TLC00003



TLC00004

 Schedule setting is only for Time Lapse mode. The maximum AVI file size is 500MB.

Full menu mode operation

DISPLAY ICONS (Full menu mode)



1. Scene
DAY: Daytime
TWLT: Twilight
NITE: Night
2. HDR
3. Schedule
4. Battery indicator
5. Scene setting
6. Menu/Info
7. Schedule setting

1. CAPTURE MODE SETTINGS

- 1-1. At PREVIEW SCREEN, press “◀” button to go to CAPTURE MODE SCREEN.
- 1-2. Press “◀” and “▶” to select desired CAPTURE MODE and press “●” button to confirm and return to PREVIEW SCREEN.



1-1



1-2

1. CAPTURE MODES

Capture mode	Description
Time Lapse	Camera captures series of photos at a time interval of your choice, and auto combines them into a ready-to-view time lapse video.
Step Video	Camera records a short video clip at a selected capture interval, and auto combines those clips to a ready-to-view step video.
Still Photo	Capture single still photo.
Stop Motion	Manually press the shutter to take multiple photos one frame each time. The camera then auto combines those photos into a stop motion video.

1. START/STOP RECORDING

(CAPTURE MODE - TIME LAPSE & STEP VIDEO)

Start

- 1-3. Press "**SHUTTER**" button to start recording.
- 1-4. The LCD screen displays "**REC**" icon along with *beep sound*.
- 1-5. The LCD screen then turns off to save power.



1. START/STOP RECORDING

(CAPTURE MODE - TIME LAPSE & STEP VIDEO)

Stop

- 1-6. Press "**SHUTTER**" button to wake up LCD screen. The camera stops recording and starts post-editing video immediately.
- 1-7. LCD screen displays "**PROCESSING**" icon accompanied by **beep sound** to confirm the completion of video postediting.
- 1-8. The camera returns to preview screen after the video is completed.

⚠ Note: 3 beeps for time lapse mode; 4 beeps for step video mode

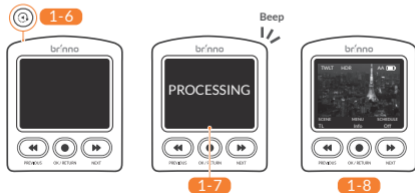

⚠ To view recorded footage, SD card must be removed or camera must be plugged into a computer using the USB-C cable.

1. START/STOP RECORDING

(CAPTURE MODE - STOP MOTION)

Start

- 1-9. Press “**SHUTTER**” button. LCD screen shows “**Initializing Stop Motion**” followed by a beep to start recording.
- 1-10. Press “**SHUTTER**” button to capture single frame.
- 1-11. LCD screen shows 4 star “* * * *” symbols sequentially. Please hold till the process finish.
- 1-12. Press “**SHUTTER**” button to capture next frame.



1. START/STOP RECORDING

(CAPTURE MODE - STOP MOTION)

Stop

- 1-13. Hold "**SHUTTER**" button for 3 seconds to stop recording. LCD screen displays "**Closing Stop Motion**" followed by a beep to confirm the completion of video post-editing.
- 1-14. The camera returns to PREVIOUS SCREEN.



 To view recorded footage, SD card must be removed or camera must be plugged into a computer using the USB-C cable.

1. START/STOP RECORDING

(CAPTURE MODE - STILL)

- 1-15. At **STILL** mode, press "**SHUTTER**" along with beeps to capture one photo each time.



To view recorded footage, SD card must be removed or camera must be plugged into a computer using the USB-C cable.

2. MENU SETTINGS

- 2-1. At PREVIEW SCREEN, press “●” button to go to **MENU SETTINGS** screen.
 - 2-2. At **MENU SETTINGS**, press “◀” or “▶” button to switch to menu options.
 - 2-3. Press “●” button to enter the setting.
- * **SKIP BUTTON:** Press “**SHUTTER**” button to go back to PREVIEW SCREEN.



2-1



2-2



2-3



SKIP BUTTON

2. MENU (FULL MENU MODE)

Option	Level I	Level II
INFO	Display current camera status	
MENU	Quick menu Full menu	
CAPTURE MODE	Time Lapse Step Video Still Stop Motion	
INTERVAL	ASAP ~ CUSTOM (Interval options depends on selected exposed mode)	
EXPO MODE	Daytime/Twilight/Night	
HDR	OFF/ON	
FLICKER FILTER	None/60 Hz/50 Hz	

2. MENU (FULL MENU MODE)

Option	Level I	Level II
SCHEDULE	Off	
	Continuous	Camera will autocombine several daily AVI files into a single file.
	Daily	Every daily recording produces a single AVI file.
*Only for Time Lapse mode, information refer to page 33-35.		
IMAGE SETTING	WHITE BALANCE	Auto/tungsten fluorescent (1)/fluorescent (2)/cloudy/shadow/daylight
	EV	
	CONTRAST	
	SATURATION	
	SHARPNESS	
	Restore image defaults	OK/Cancel
	Return	Return to Main Menu

2. MENU (FULL MENU MODE)

Option	Level I	Level II
MORE	LED indicator	Yes/No
	DATE & TIME	Set camera date & time
	TIME STAMP	Yes/No
	BAT TYPE	Alkaline/NiMh/Lithium
	RESOLUTION	720P/1080P
	FOCUS	Zoom in/Zoom out/Ok to Exit
	PLAYBACK FPS	1/5/10/20/30/Custom
	System Info.	Camera firmware version
	FORMAT SD CARD	Yes/No
	RESET CAMERA	Yes/No
	RETURN	Return to Main Menu
RETURN	Return to Main Menu	

3. INTERVAL SETTING

- 3-1. At PREVIEW SCREEN, press “▶” button to go to INTERVAL SETTINGS.
- 3-2. Select desired **Interval**, press “●” button to confirm and go to PREVIEW SCREEN.



EXPO mode	Interval options
Daytime	ASAP,1,2,3,5,10,20,30 SEC/1,2,3,5,10,20,30 MIN/Custom
Twilight	3,5,10,20,30 SEC/1,2,3,5,10,20,30 MIN/Custom
Night	10,20,30 SEC/1,2,3,5,10,20,30 MIN/Custom

3. INTERVAL SETTING (STEP VIDEO MODE)

- 3-3. At PREVIEW SCREEN, press “▶▶” button to go to **INTERVAL SETTINGS**.
- 3-4. Select desired **Burst length** and press “●” button to confirm and go to next setting.
- 3-5. Select desired Burst Interval and press “●” button to confirm and go to the PREVIEW SCREEN.



3-3



3-4



3-5

! 30 Sec Burst Interval option is only for **3 Sec** Burst Length mode.

SPECIFICATIONS

Model	TLC2000/TLC2020
Resolution	1080P
Aperture	F2.0
Field of View	118°
Capture Mode	Time Lapse; Step Video; Still; Stop Motion
LCD Screen	2.0" TFT LCD
Storage	microSD/microSDHC/microSDXC (up to 128 GB, recommend a minimum of Class 10)
Power Source	AA Batteries DC IN 5V 1A (USB-C connector)
Operating Temperature	32 °F ~ 113 °F (0 °C ~ 45 °C)
Size (WxHxD)	2.4x 2.8x 1.7 in (60x 70.6x 42.4 mm) TLC2000 2.4x 2.8x 1.8 in (60x 70.6x 46.6 mm) TLC2020
Weight	3.0 oz (87.5g) TLC2000 3.4 oz (97.5g) TLC2020 (without batteries)

BATTERY SETTINGS

To optimize the battery life of your TLC2000/TLC2020, please set the battery type in your camera settings.

1. Click the “●” button and go through the setting screen using the “▶” button until MORE.
2. Click the “●” button and then use the “▶” button until you get to BAT TYPE.
3. Click into the BAT TYPE page using the “●” button and select your battery type using the “◀” and “▶” buttons, confirm your setting using the “●” button.



1



2



3

DOWNLOADING & INSTALLING THE LATEST FIRMWARE

Step 1. Prepare items



Camera with full charged batteries



USB-C cable



DC Adapter



*microSD card

⚠ We recommend that the microSD card that came with the camera be used for all firmware updates. If you are using a new SD card that is over 32GB it will need to be formatted by your camera before it can be used. To format a new SD card, insert the card into your camera and follow the formatting prompts on the LCD screen before you start the firmware upgrade process.

Step 2. Copy FW file to microSD card

⚠ MUST DOWNLOAD FIRMWARE WITH *WINDOWS ONLY (NOT COMPATIBLE WITH MAC)*

1. Power off the camera.
2. Install fully-charged batteries.
3. Take out microSD card and insert it to PC (Windows).
4. Download firmware zip file from:
www.brinno.com/support/download#TLC2000series
5. Right click zip file and click <extract all> to access firmware file.
6. Open folder and **ONLY** copy the TLC2K_C.RCF file to microSD card in the 100TLC2K folder(F:DCIM/100TLC2K). The 100TLC2K folder can be accessed through the DCIM folder.

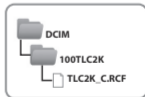

DOWNLOADING & INSTALLING THE LATEST FIRMWARE

Step 3. Start FW upgrade

7. Insert the microSD card into the camera.
8. Connect the camera to external power using the USB-C cable.
9. Camera will automatically turn on and upgrade firmware. The LED indicator will flash orange while firmware is upgrading.
10. When the upgrade is completed the camera will beep twice and restart automatically. The LCD screen will turn on when the upgrade is finished.



Connect the camera to external power

Note:

1. The firmware upgrade process is expected to be less than 10 minutes.
2. If the Orange LED flashes longer than 10 minutes, it means the upgrade was not successful. Follow the below steps:
 - a. Disconnect the external power and remove the batteries from the camera.
 - b. Format the microSD card on PC (Windows) one more time.
 - c. Copy firmware file (TLC2K_C.RCF) to (TLC2K_C.RCF) into the microSD card (F:\DCIM\100TLC2K).
 - d. Make sure you follow the instructions closely. Please write to our Customer Service if you have further questions.

Support

TUTORIAL VIDEO

Scan the QR code to watch the video tutorial.



www.brinno.com/support/tutorial/TLC2000-tutorial

TIME LAPSE CALCULATOR

Scan the QR code to calculate Time Lapse setting.



www.brinno.com/support/time_setting_calculator

STAY UP TO DATE

The product features, specifications sheets and instructions may differ from actual products. Please refer to Brinno official site for the latest version of user manual.



www.brinno.com/support/download

